

60" X 36" X 3 5/8"

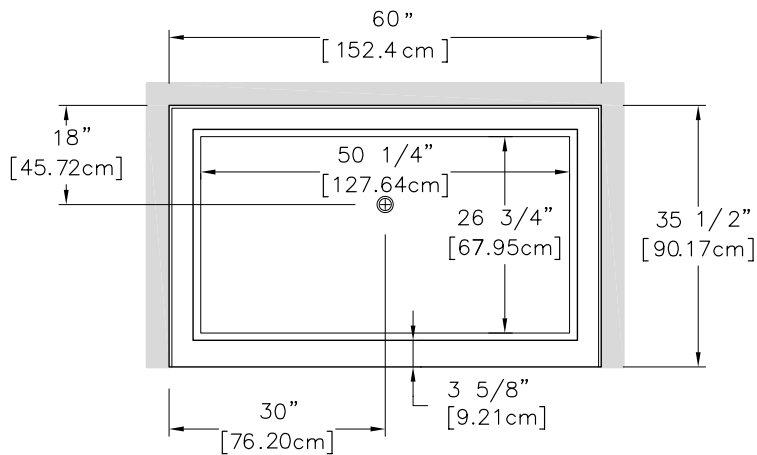

SHERLIC showers come with a superior quality finish that requires protection during shipping and handling. The high gloss surface is shock resistant and will conserve its appearance for years to come if properly cared for and maintained. It is the consignee's responsibility to advise the shipper of any damage incurred in transit. Any missing items must be carefully indicated on the receiving slip.

DO NOT USE ABRASIVE CLEANSERS, METAL SCRAPERS OR ANYTHING ELSE THAT COULD SCRATCH OR DULL THESE SURFACES.