

40" X 40" X 79 1/4"

FIGURE 1

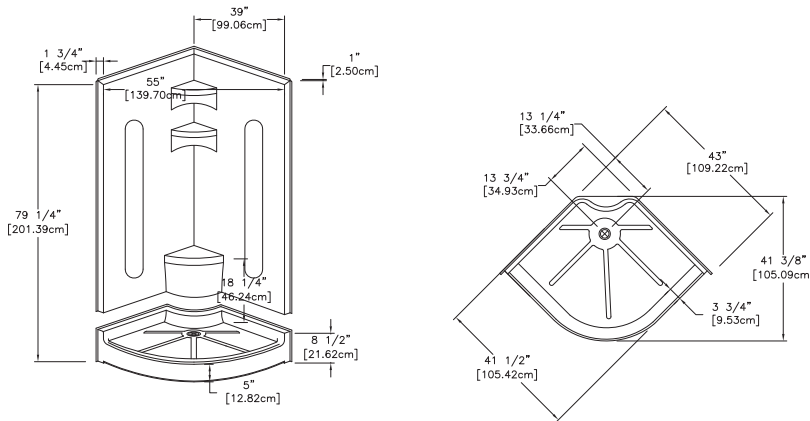
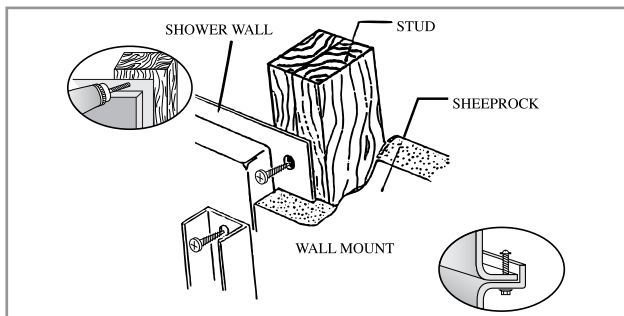

FIGURE 2



SHERLIC showers come with a superior quality finish that requires protection during shipping and handling. The high gloss surface is shock resistant and will conserve its appearance for years to come if properly cared for and maintained. It is the consignee's responsibility to advise the shipper of any damage incurred in transit. Any missing items must be carefully indicated on the receiving slip.

DO NOT USE ABRASIVE CLEANSERS, METAL SCRAPERS OR ANYTHING ELSE THAT COULD SCRATCH OR DULL THESE SURFACES.

- 1- Install plumbing in compliance with local standards. Refer to Figure 1 as needed. Note: The shower should be installed so that the shower base and wall are set flush against wall studs.
- 2- Fasten additional studs as required directly behind the shower wall edge, which is designed to fasten to the wall and shower door.
- 3- Prior to installation, ensure that the studs are plumb and the floor is level, otherwise the shower wall will not line up flush with the studs once the shower is in place.
- 4- Drill a number of 1/8" holes in the shower wall edge so that they line up with the studs and ensure the shower is set perfectly flush against the studs.
- 5- Install the shower, making sure it is level, then fasten it to the studs with 1 1/4" drywall screws.
- 6- Install the shower door according to the installation instructions enclosed with the door, taking care to drill your holes in the shower wall edge before fastening the shower door "U" upright. See Figure 2.

The measurement includes the installation trim.

The measurements found in this document are approximate. SHERLIC Inc. is not responsible for installations made with the measurements indicated in this booklet or any other promotional document.